

General Information

SOUTHERN UTAH UNIVERSITY'S MISSION STATEMENT

As a community of learners, Southern Utah University serves as a comprehensive regional university to encourage a lifelong love of learning, to foster academic excellence, to instill ethics and values and to honor thought in all its finest forms. Foremost to our role and central to our disciplines are superior teaching and quality service to students. Fundamental to our purpose are scholarly activities and public service.

Our mission is to provide students a personalized learning environment to foster meaningful experiences involving the mind, heart and hands, which:

1. Affirm integrity, the search for truth and respect for all people as the foundation of education;
2. Develop communication, analytic, creative and information gathering skills;
3. Prepare students as informed and responsible citizens and for effective roles in families and other societal organizations;
4. Afford opportunities for success in students' personal and professional lives by providing service and leadership experiences in a residential campus setting;
5. Enhance economic, technological and cultural development of the communities served.

Southern Utah University provides baccalaureate, applied technology, and selected graduate education. We address the unique needs of rural students and communities; serve as a major cultural center for southern Utah; and create partnerships with public and higher education, government, business and industry.

SOUTHERN UTAH UNIVERSITY
PROFILE
 January 2002

Southern Utah University established: 1897
 Public, Comprehensive, Coeducational, Masters I University
 Accreditation: Northwest Association of Colleges and Schools
 President: Steven D. Bennion
 Calendar: Semester

Enrollment:

Fall Headcount 6,095
 Fall FTE 5,229

Residency of Students:

Utah 5,030 82.5%
 Non-Utah 1,065 17.5%

Number of Fall FTE Faculty:

244

Utah Counties:

Southern 15 counties 3,433 56.3%
 Northern 14 counties 2,136 35.0%
 Non-Utah 526 8.6%

Number of employees:

Payroll 658
 Hourly 115

Gender:

Male 2,714 44.5%
 Female 3,381 55.5%

Dorm capacity: 395

Average age (all students): 23.4

Ethnicity:

Asian 126 2.1%
 Black 32 0.5%
 Hispanic 106 1.7%
 Native American 63 1.0%
 Native Hawaiian
 Or Pacific Islander 26 0.4%
 Other 18 0.3%
 White 5,642 92.6%
 Unspecified 82 1.3%

Degree programs:

Associate's 26
 Bachelor's 62
 Master's

12

Land and Facilities:

Campus acreage 133
 Valley farm acreage 1,032
 Mountain property 2,502
 Other property 177
 Total 3,844

**Six-year graduation rate
 for 1995 cohort:**

31.8%

Number of buildings: 75

Average ACT score: 21.20

No. of square feet in inventory: 1,311,108

2000-01 Avg. Faculty Workload: 12.5

**FTE Faculty to FTE Student Ratio
 (Budget)**

2000-01 Cost Study 21.64

**2000-01 Avg. Years for a Bachelor's
 Degree:** 5.1

**2000 Graduates with Bachelor Degrees
 Seeking Employment:** 2.85%

GENERAL OFFICERS OF ADMINISTRATION

Office of the President

President	Steven D. Bennion
Assistant Attorney General/Legal Counsel	D. Michael Carter
Director of Marketing and Public Relations	Dean O'Driscoll

Academic Affairs

Provost (Interim)	Carl R. Templin
Associate Provost	Michael D. Richards
Assistant Provost for Information Technology	Glen Pryor

Administrative and Financial Services

Vice President	Gregory Stauffer
Associate Vice President	Dorian Page
Director, Intercollegiate Athletics	Thomas Douple

Advancement and Regional Services

Vice President	Stuart C. Jones
----------------	-----------------

Student Services

Vice President	Sterling R. Church
Associate Vice President	Georgia Beth Thompson
Assistant Vice President	D. Mark Barton

Deans

Dean, School of Applied Science and Technology	Vacant
Dean, Business and Technology	Carl Templin
Dean, School of Continuing and Professional Studies	Lou J. Workman
Dean, Education	Bruce Barker
Dean, Humanities and Social Sciences	Rodney D. Decker
Dean, Library	Diana T. Graff
Dean, Performing and Visual Arts	Charles Metten
Dean, Science	Harold Ornes

Department Chairs

Accounting and Information Systems*	Vacant
Applied Science	Vacant
Applied Technology	Richard Wittwer
Art	Brian P. Hoover
Biology	Vacant
Communication	Jon M. Smith
Economics and Finance*	Vacant
English	Vacant
Foreign Languages and Humanities	Vacant
Management and Marketing*	Vacant
Mathematics and Computer Science	Mikhail M. Bouniaev
Music	Bart Shanklin
Physical Education	Craig Morrison
Physical Science and Engineering	Desmond Penny
Psychology	Leslie N. Jones
Social Sciences	Earl Mulderink
Teacher Education	Prent Klag
Theatre Arts and Dance	Terral S. Lewis

Accreditation of Programs

General University Accreditation: Northwest Association of Schools and Colleges.

<u>College</u>	<u>Department/Major</u>	<u>Agency</u>
Performing & Visual Arts	Music	National Association of Schools of Music
	Music Education	
Business & Technology	Accounting	Association of Collegiate Business Schools & Programs
	Economics	
	Finance	American Association of Collegiate Schools Of Business (Candidacy)
	Management Information Systems	
	Managerial Economics	
Education	Elementary Education	National Association State Directors of Teacher Education and Certification Special Education
	Secondary Education	
	Teacher Education	Utah State Department of Public Instruction National Council for Accreditation of Teacher Education (pre-candidacy)
Science	Nursing (w/ Weber State Univ.)	National League for Nursing Utah State Board of Nursing

Southern Utah University Peer Institutions

Boise State University
California State University at Dominguez Hills
Clarion University of Pennsylvania
Indiana University/Purdue University at Fort Wayne
University of North Florida
University of Northern Iowa
University of Wisconsin at Whitewater
Western Carolina University
Western Washington University
Youngstown State University

Association Memberships

- ▶ American Association of Adult & Continuing Education
- ▶ American Association of College of Nursing
- ▶ American Association of College Registrars and Admissions Officers
- ▶ American Association of Colleges for Teacher Education
- ▶ American Association for Higher Education
- ▶ American Association of State Colleges and Universities
- ▶ American Association of University Women
- ▶ American Council on Education
- ▶ American Library Association
- ▶ Association of American Colleges and Universities
- ▶ Association of College and Research Libraries
- ▶ Association for Continuing Higher Education
- ▶ Association for Institutional Research
- ▶ The College Board
- ▶ Council for Advancement and Support of Education
- ▶ EDUCAUSE
- ▶ National Association of College and University Business Officers
- ▶ National Association of Rural Health
- ▶ National Association for Schools of Music
- ▶ National Association of Student Financial Aid Administrators
- ▶ National Collegiate Athletic Association
- ▶ National League for Nursing
- ▶ National Rural Education Association
- ▶ North American Association of Summer Sessions
- ▶ Society for College and University Planning
- ▶ University Continuing Education Association (UCEA)
- ▶ Utah Academic Library Consortium
- ▶ Western Association of Summer Session Administrators
- ▶ Western Interstate Commission for Higher Education (WICHE)

* The above listing is only to be representative of the major types of memberships held by the University.

Clubs & Organizations

- The Academy**, *Building business connections.*
- Alpha Epsilon Delta**, *Club relating to health care majors.*
- Alternative Spring Break Club**, *Spend your spring break in Mexico doing service.*
- Alpha Phi**, *International women's fraternity.*
- Alpine Club**, *For all outdoor winter sports lovers.*
- Best Buddies**, *Students interaction w/people that have disabilities.*
- Black Student Alliance**, *Sharing African American culture and history.*
- Block and Bridal**, *An agricultural club.*
- Campus Christian Fellowship**, *Christians serving humankind on campus.*
- Centurium Consulting**, *Student run full service public relations firm on campus.*
- Change**, *Performing acts of service in Africa during the summer.*
- Cheer Squad**, *The club consists of the cheer and yell squad.*
- College Democrats**, *To promote the Democratic party.*
- College Republicans**, *To promote the republican party.*
- Color Guard**, *Performs at home games and other school functions.*
- Delta Epsilon Chi**, *Leadership, management, & marketing recognition.*
- Delta Psi Omega**, *A local women's sorority.*
- Earth Club**, *Promoting recycling and environmental awareness.*
- Education Club**, *Education majors are encouraged to join.*
- Geology Club**, *An academic experience in Geology.*
- Health Occupation Students of America**, *For all students entering the field of health occupations.*
- Hispanic Club**, *Latin American & Spanish cultural exposure to anyone.*
- Human Resource**, *Anyone entering the human resource profession.*
- Infinite Kingdom of Learning**, *Club for science & math majors entering education.*
- International Club**, *Foreign students interact w/American Culture.*
- Kappa Kappa Psi**, *The national fraternity for band members.*
- Lambda Delta Sigma (LDS)**, *A sorority.*
- Lambda Pi Eta**, *Communication Honor Society.*
- LDSSA (Latter-Day Saint Student Association)**, *Sponsor activities for LDS and non-LDS students.*
- Linux**, *A free unique-like computer operating system.*
- Masque Club**, *Student's aspiring to enter the theatrical arena.*
- Men's Soccer**, *Designed for soccer lovers.*
- Mountain Biking Club**, *For all who love to go mountain biking.*
- Movie Club**, *An opportunity to be exposed to a variety of films.*
- Music Club**, *The most jammin' club on campus.*
- Native American Student Association**, *Cultural enrichment and activities to the campus community.*
- Newman Club**, *Catholic religious organization for anyone interested.*
- Orchesis**, *SUU's modern dance company.*
- Phi Beta Lambda**, *National honor society for Political Science majors.*
- Phi Sigma Alpha**, *National honor society for Political Science majors.*
- Polynesian Club**, *Reflecting Polynesian traditions w/great activities.*
- Power 91**, *Live radio experience and lots of fun too!*
- Presidential Ambassadors**, *Aid school relations w/providing tours & information for new students.*
- PRIDE**, *To educate on the role of gay, lesbian and bisexual citizens.*

Professional Accountancy Club, *Preparing you for success in the business world.*
Psi Chi, *National honor society for Psychology majors.*
Residential Housing Association, *For the betterment of all on campus activities.*
ROTC, *An educational military experience.*
Sigma Chi, *An international men's fraternity.*
Sigma Delta Omicron, *Home Economics, child development, interior design, etc.*
Sigma Gamma Chi, *A fraternity.*
Sigma Nu, *An international men's fraternity.*
Sign Language, *Information and helping students learn and do sign.*
Ski and Snowboarding, *For all levels of snow skiers and boarders.*
Society of Professional Journalism, *All interested in print, TV, radio, or internet communications.*
Speak Out Club, *To improve and promote public speaking skills.*
Student Council for Exceptional Children, *Improve education for children w/exceptional abilities.*
Students for Campus Diversity, *Educate & learn about all diversity interests on campus.*
Students for Social Activism, *Proactive students seeking & creating social change.*
Student Nurses Association, *Career networking w/health care, community service, & fun.*
Student Reading Council, *To enhance literacy in the community and at school.*
SU Hollywood, *Student produced films.*
Swimming Club, *Everyone who enjoys recreational and competitive swimming.*
T-bird Martial Arts, *For anyone interested in martial arts.*
Tennis Club, *For all of you Tennis lovers.*
T.V. Club, *For anyone interested in broadcasting.*
VICA (Vocational Industrial Clubs of America), *Club designed for vocational and technical majors.*
Volleyball Club, *For all those who love to bump, set, and spike.*
Waukeenyans, *Dancers that support teams & promote school spirit.*
Wrestling Club, *Those who wish to wrestle for fun or compete in NCWA.*
Zeta Tau Alpha, *An international Women's fraternity.*

Southern Utah University Presidents

Milton Bennion	1897-1900
J. Reuben Clark, Jr.	1900-1901
Nathan T. Porter	1901-1904
George W. Decker	1904-1913
Roy F. Homer	1913-1921
Peter V. Cardon	1921-1922
J. Howard Maughan	1922-1929
Henry Oberhansley	1929-1945
H. Wayne Driggs	1945-1951
Daryl Chase	1951-1953
Royden C. Braithwaite	1955-1978
Orville D. Carnahan	1978-1981
Gerald R. Sherratt	1982-1997
Steven D. Bennion	1997-

Southern Utah University

President's Council Organizational Chart

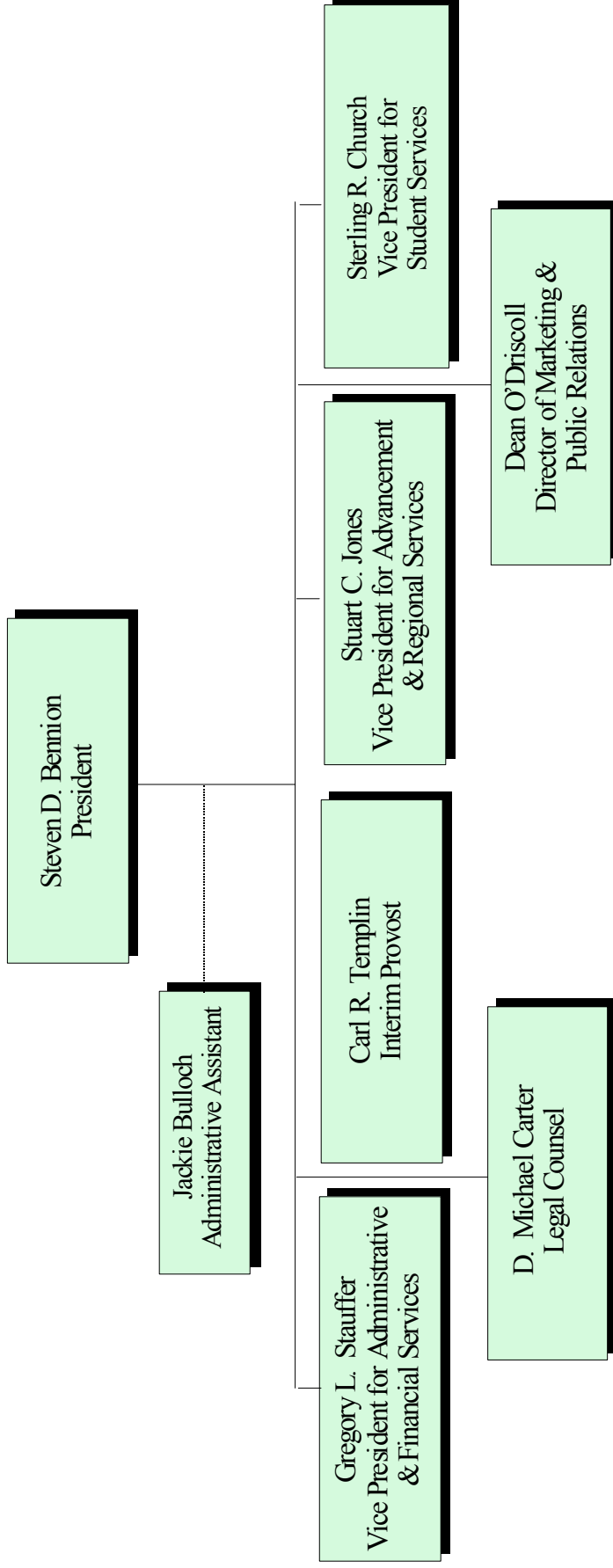

Southern Utah University

University Advancement Organizational Chart

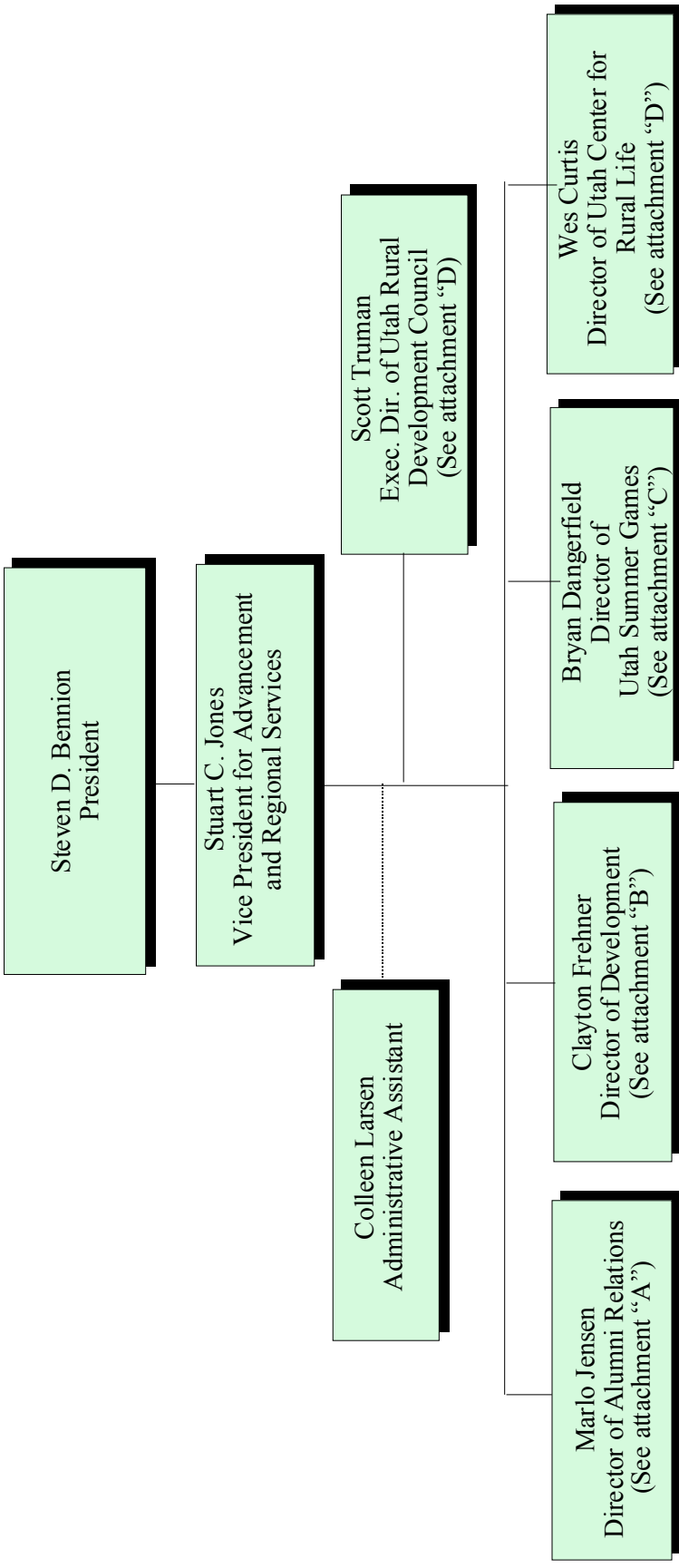

Southern Utah University

University Advancement Organizational Chart Attachment "A" Alumni Relations

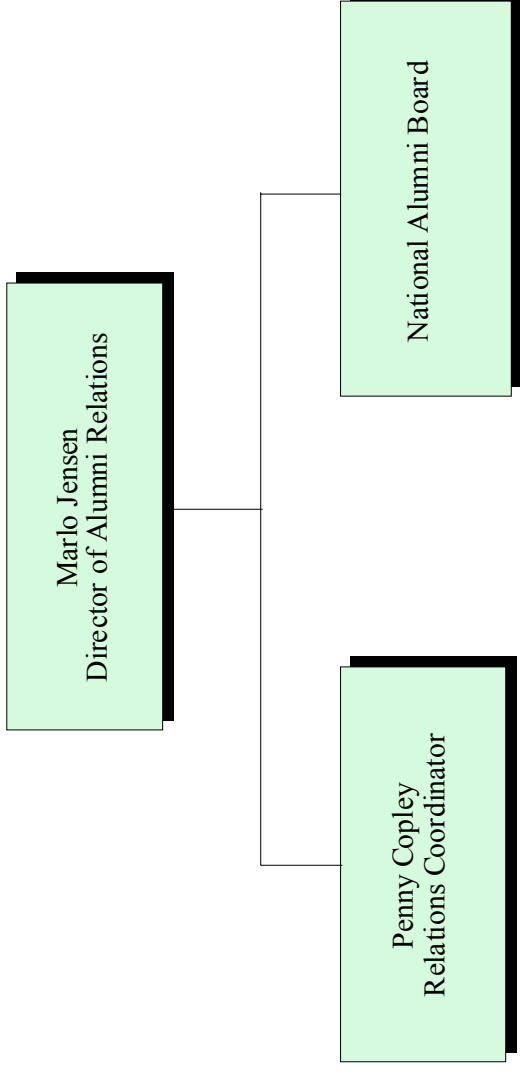

Southern Utah University

University Advancement Organizational Chart

Attachment "B"

Development

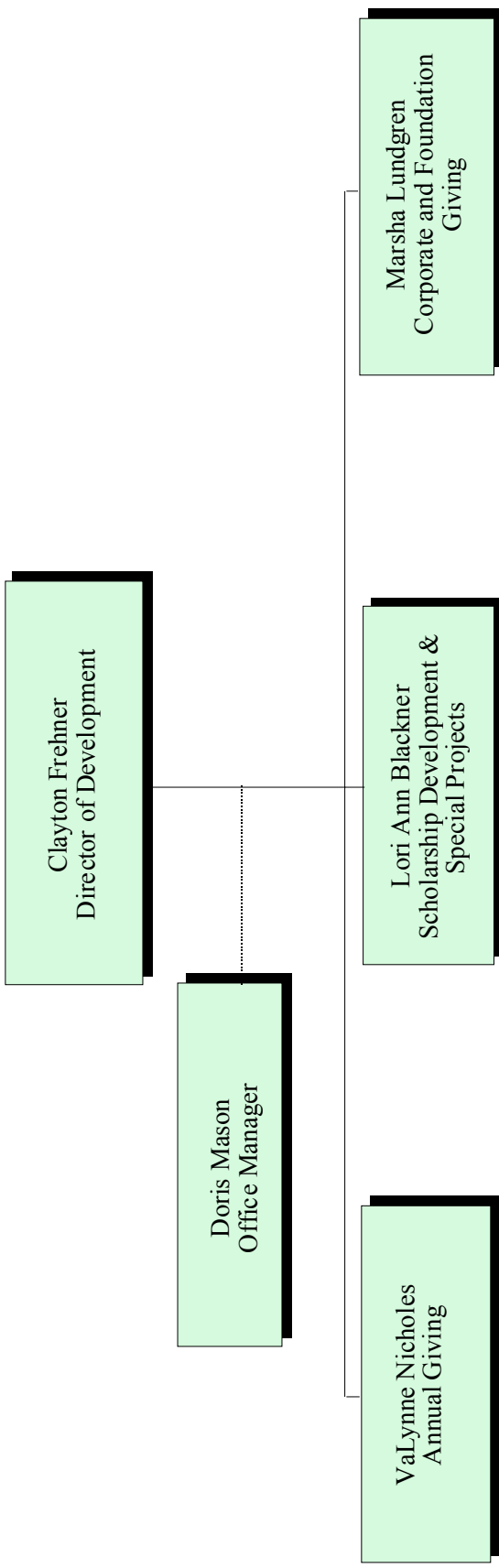

Southern Utah University

University Advancement Organizational Chart

Attachment "C"
Utah Summer Games

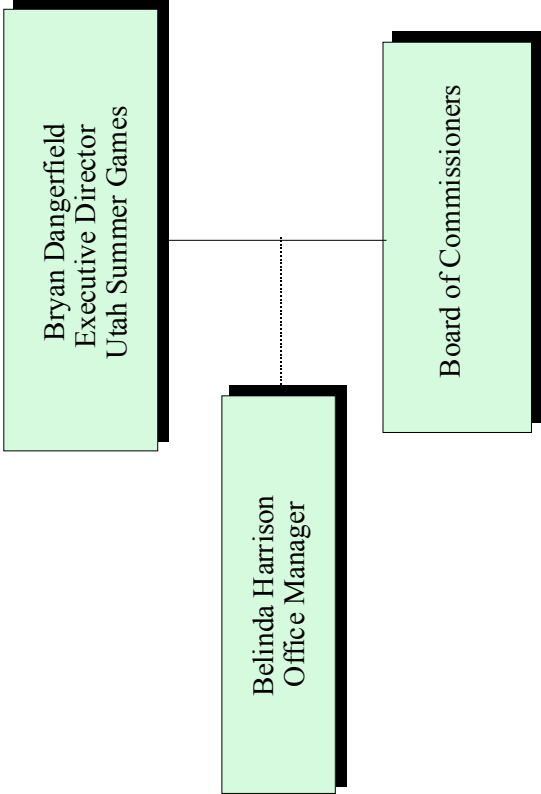

Southern Utah University

University Advancement Organizational Chart

Attachment "D"

Regional Services

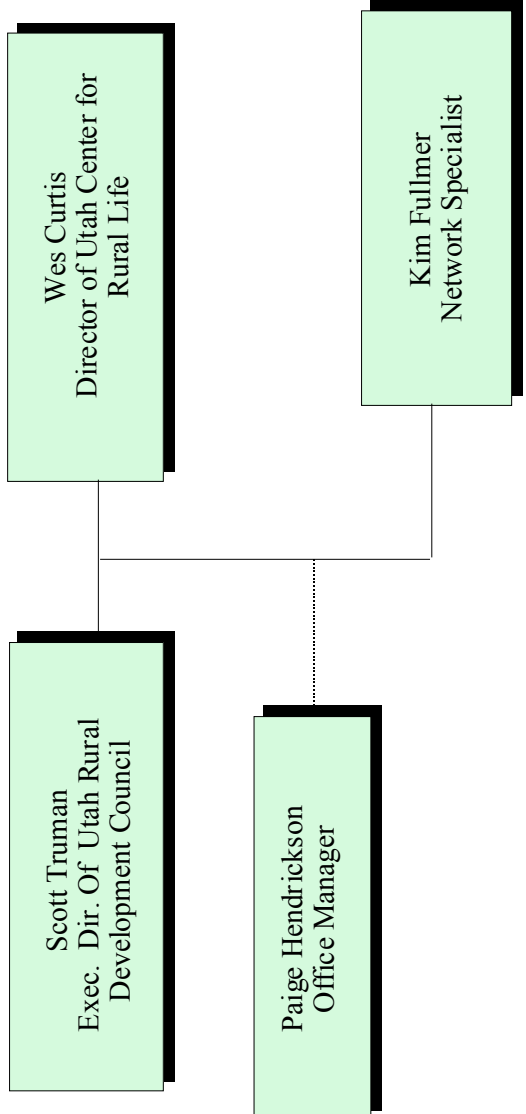

Southern Utah University

Academics Organizational Chart

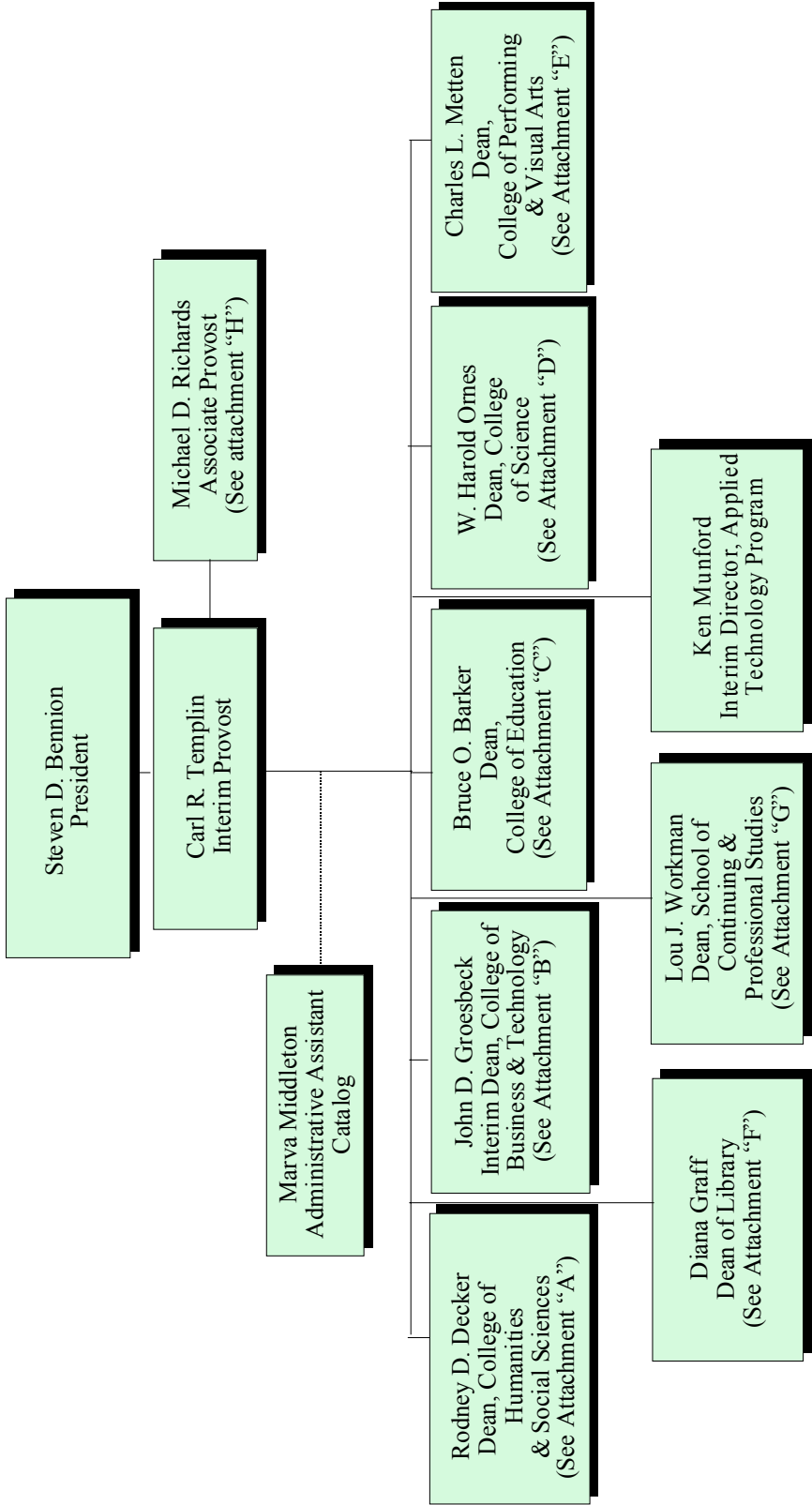

Southern Utah University

Academics Organizational Chart

Attachment "A"

College of Humanities & Social Sciences

Rodney D. Decker
Dean, College of Humanities &
Social Sciences

Dianne Werber
Secretary

Wayne K. Hinton
Department Chair
Social Sciences

W. David Lee
Department Chair
Language & Literature

Kay K. Cook
Associate Chair

Suzanne Larson
Director,
Honors Program

Leslie N. Jones
Department Chair
Psychology

Jon M. Smith
Department Chair
Communication

Rodney D. Decker
Director, Center for
Politics & Public Service

Southern Utah University

Academics Organizational Chart

Attachment "B"

College of Business & Technology

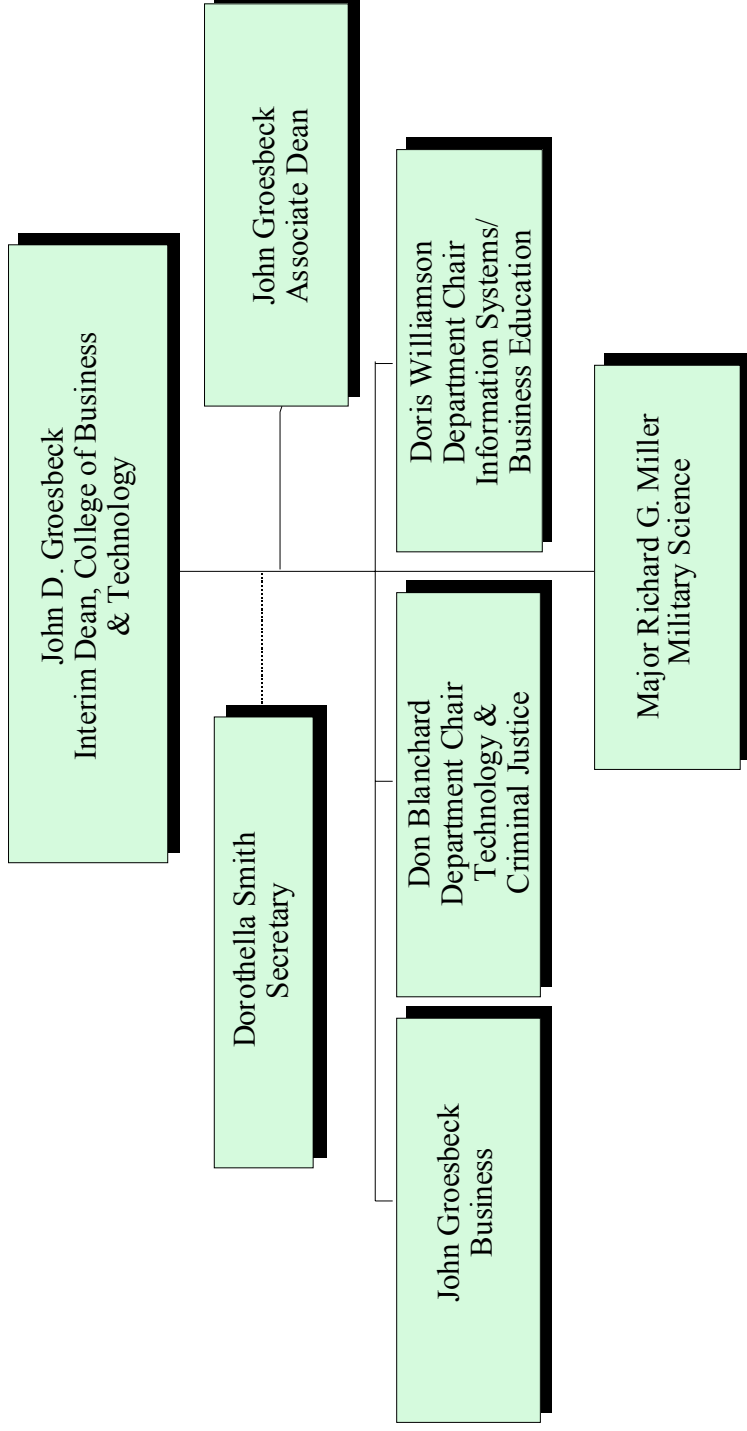

Southern Utah University

Academic Organizational Chart

Attachment "C"

College of Education

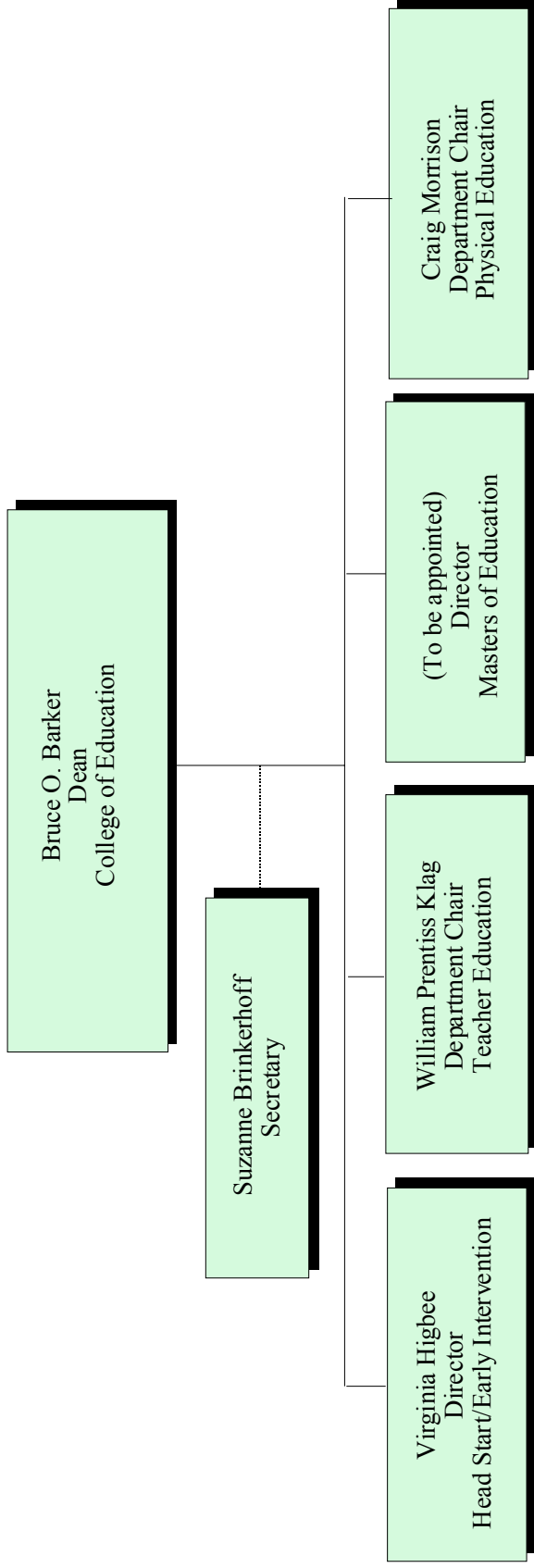

Southern Utah University

Academics Organizational Chart

Attachment "D"
College of Science

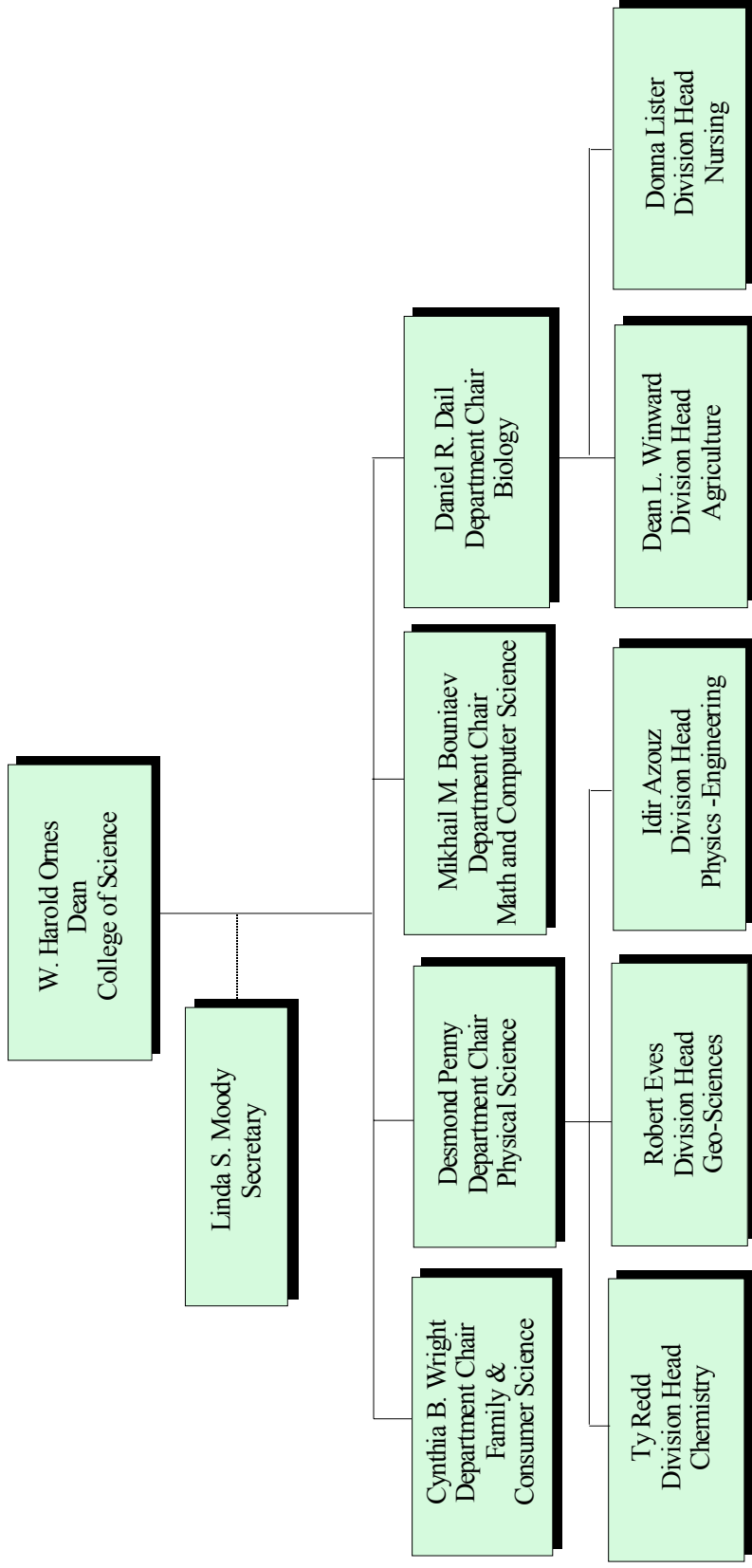

Southern Utah University

Academics Organizational Chart

Attachment 'E' College of Performing & Visual Arts

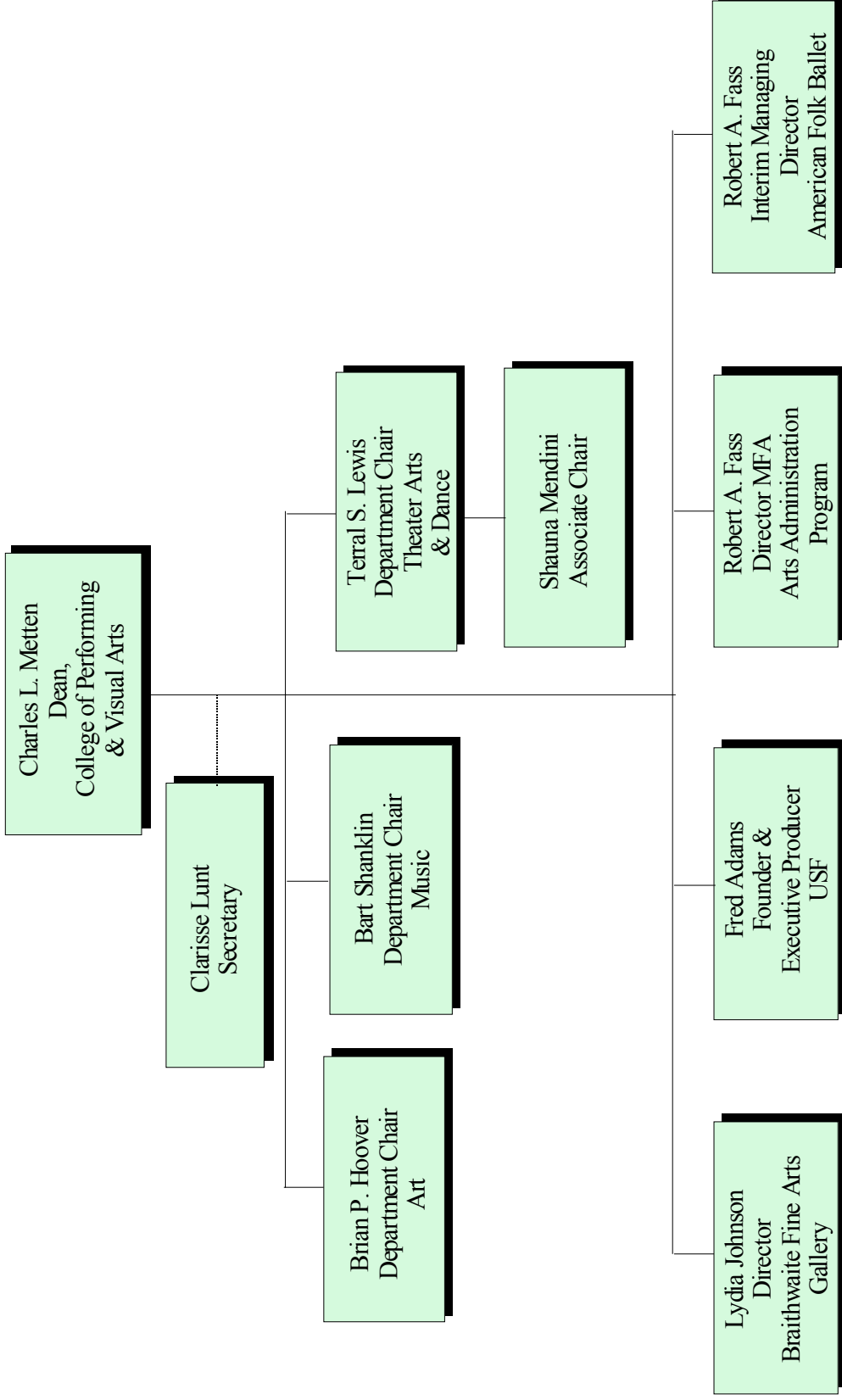

Southern Utah University

Academics Organizational Chart

Dean, Library Services
Attachment "F"

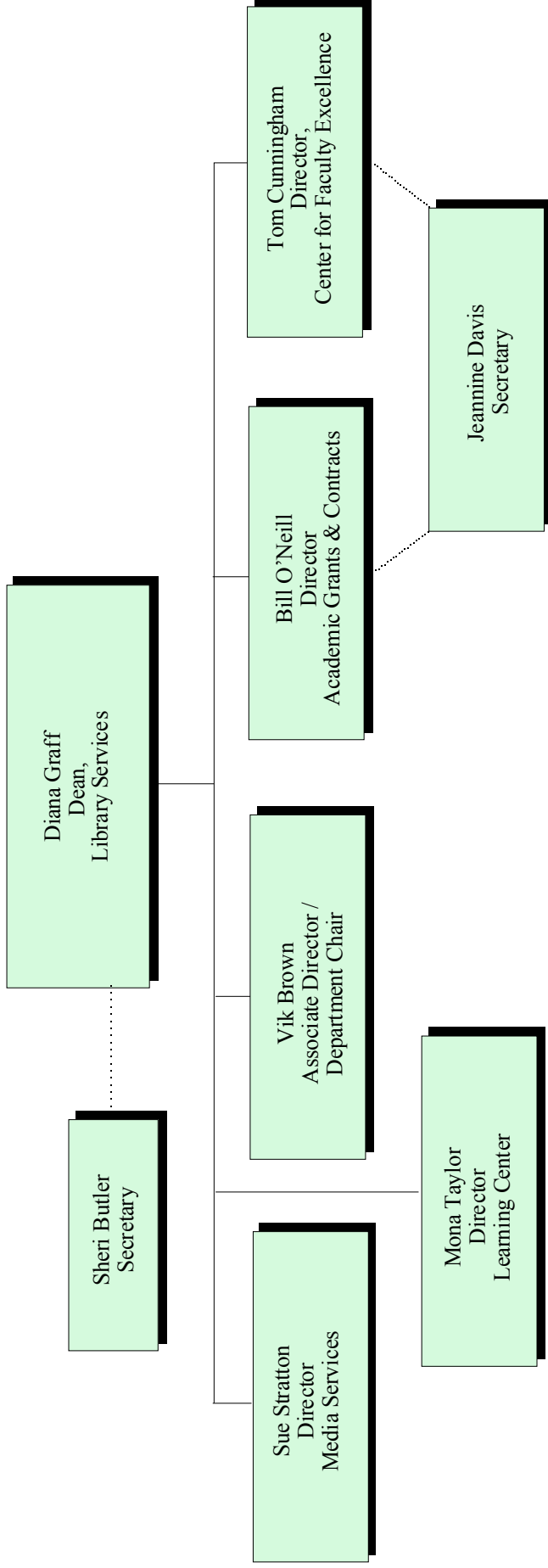

Southern Utah University

Academics Organizational Chart

Dean, School of Continuing & Professional Studies
Attachment "G"

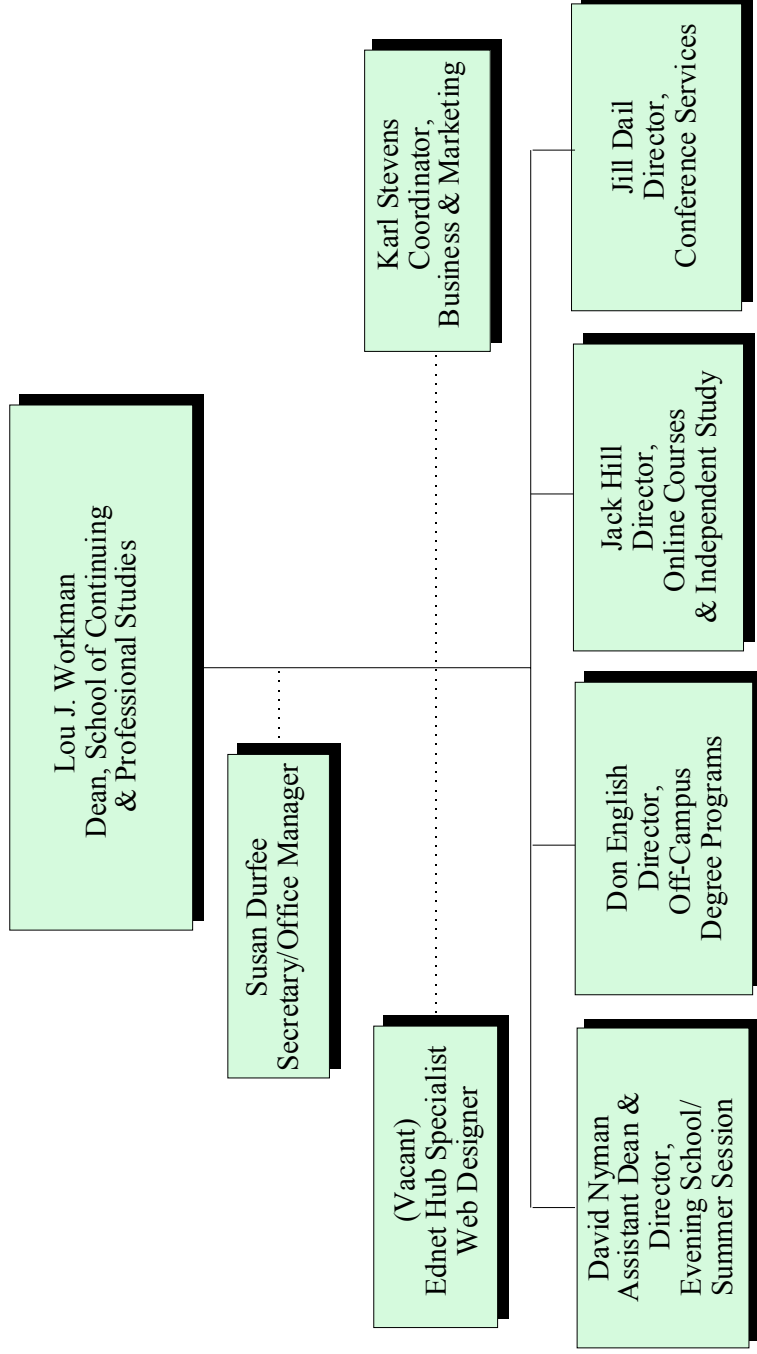

Southern Utah University

Academics Organizational Chart

Attachment "H"

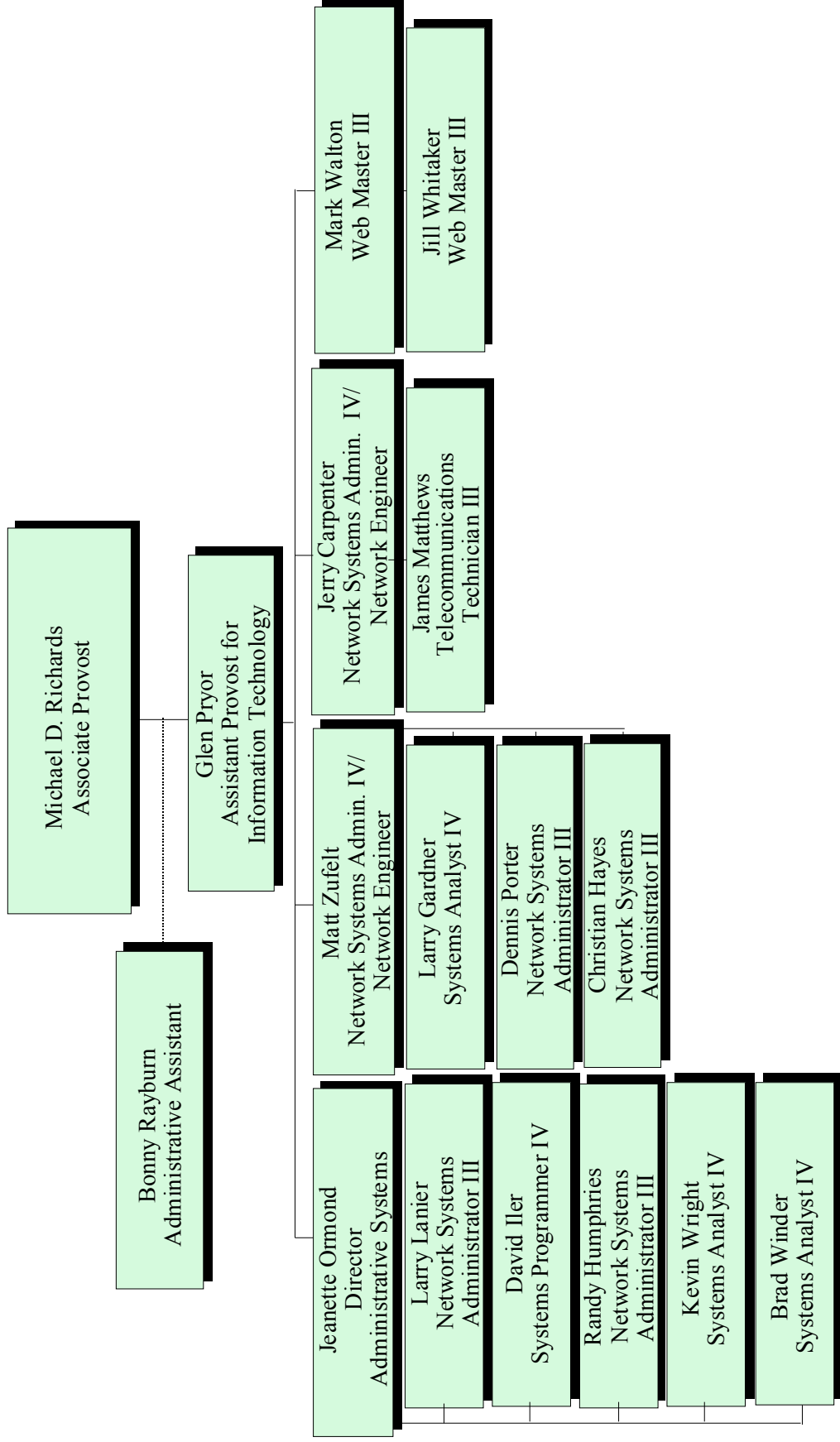

Southern Utah University Student Services Organizational Chart

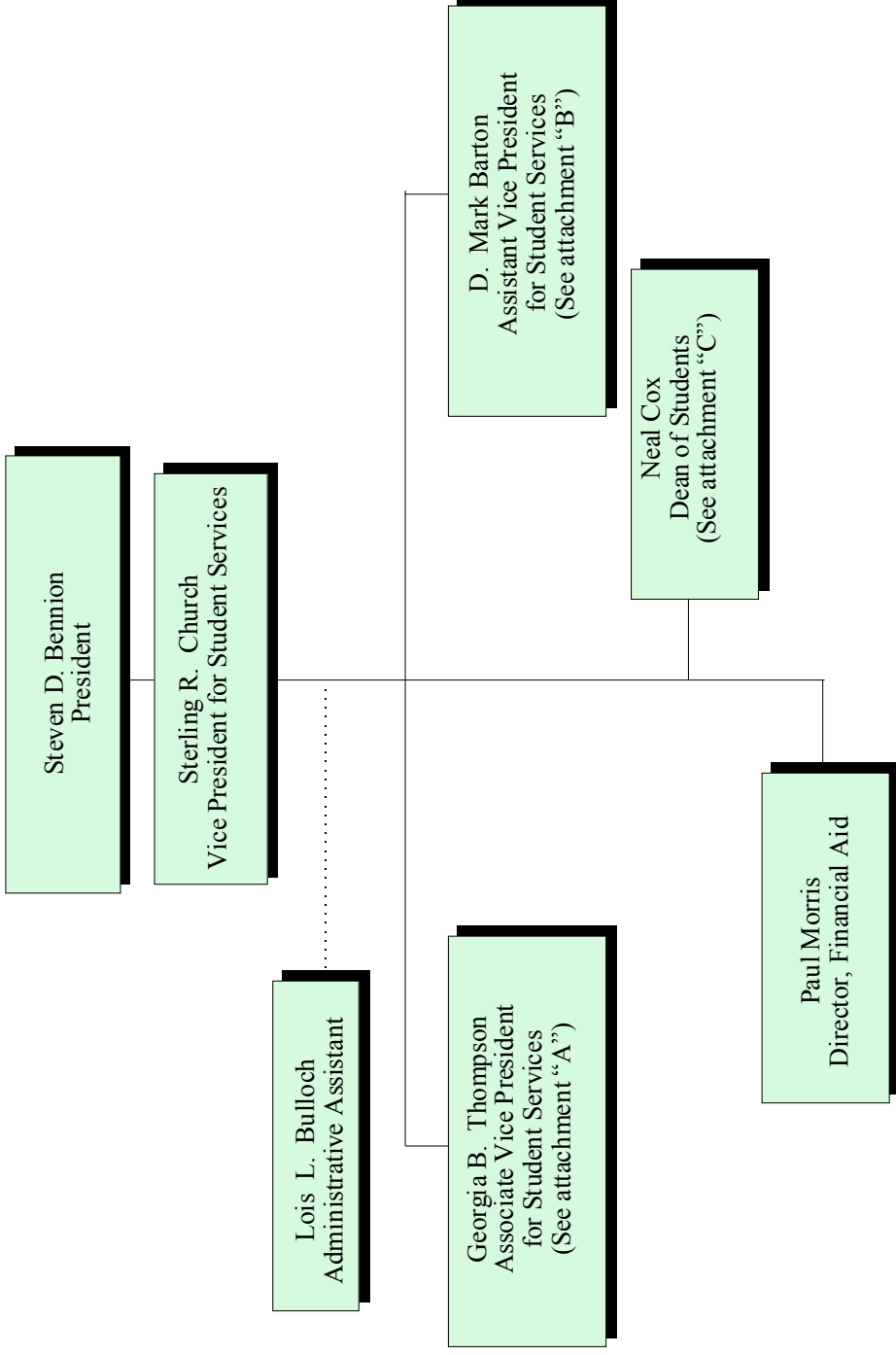

Southern Utah University

Student Services Organizational Chart

Attachment "A"

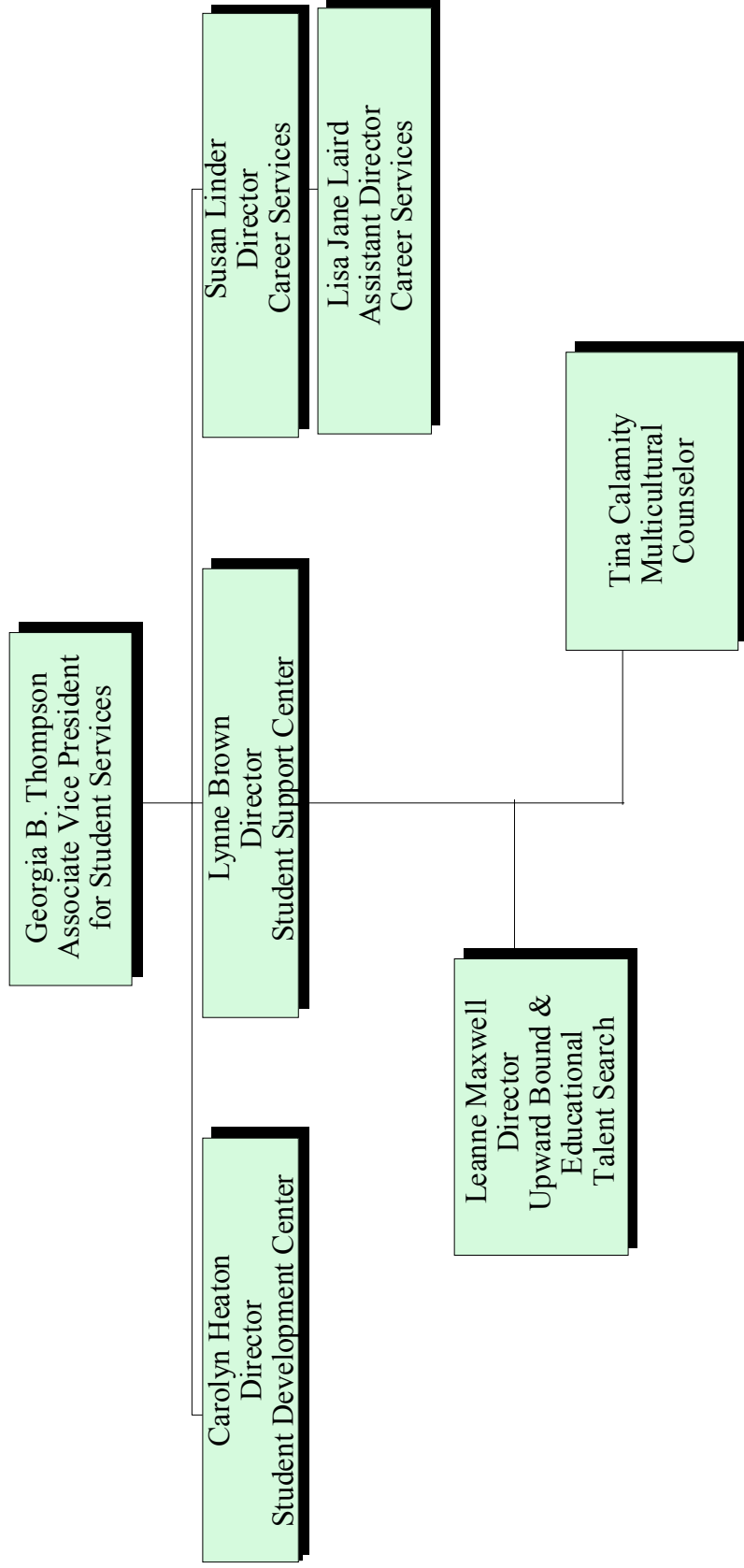

Southern Utah University

Student Services Organizational Chart

Attachment “B”

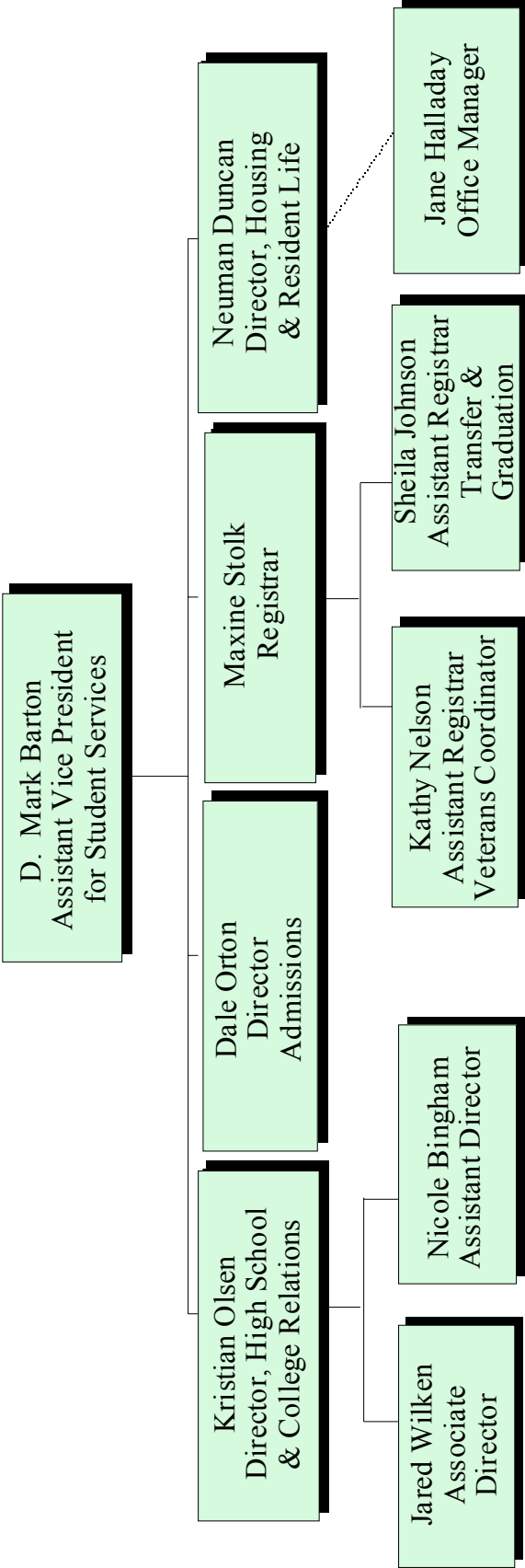

Southern Utah University

Student Services Organizational Chart

Attachment "C"

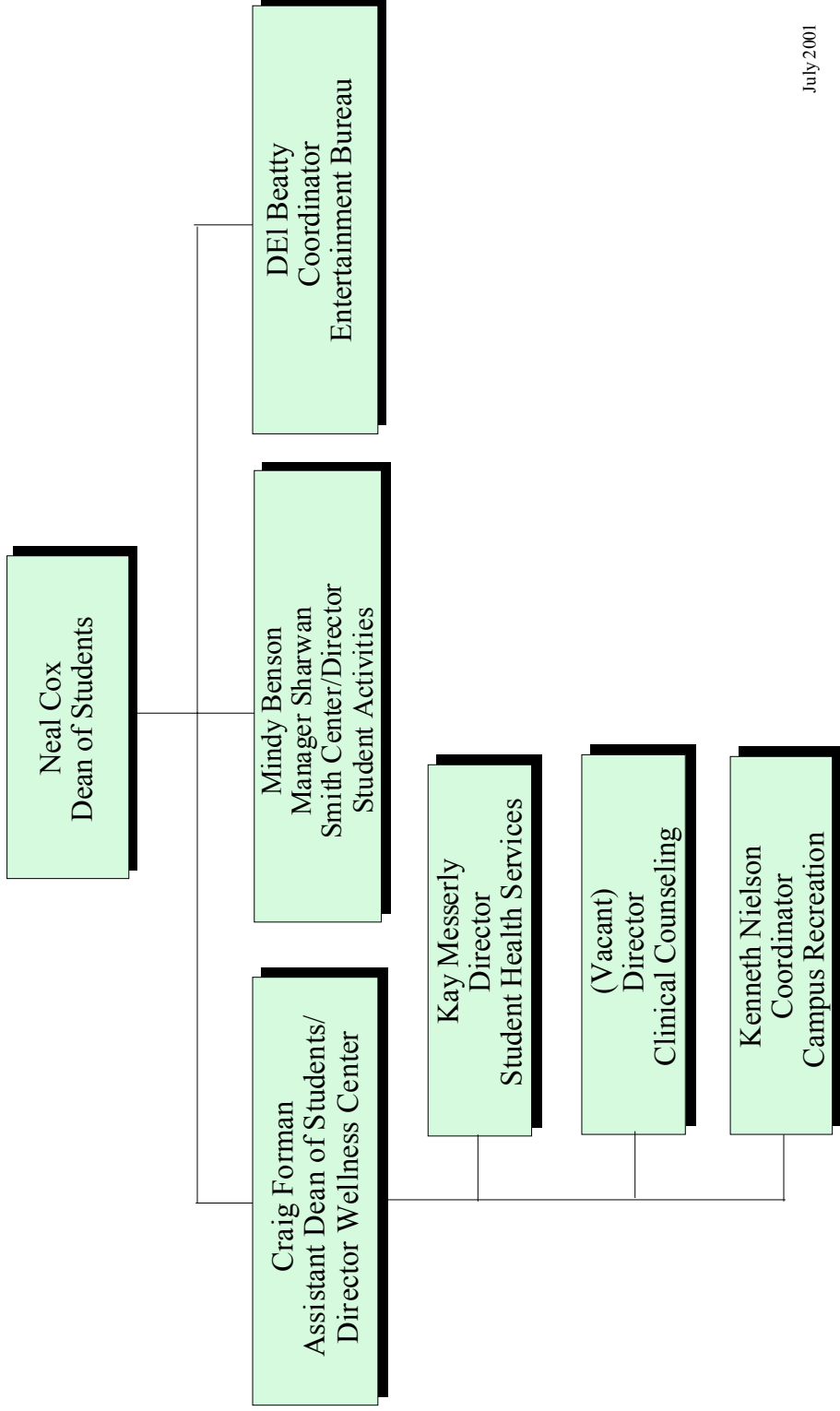

Southern Utah University

Public Relations Organizational Chart

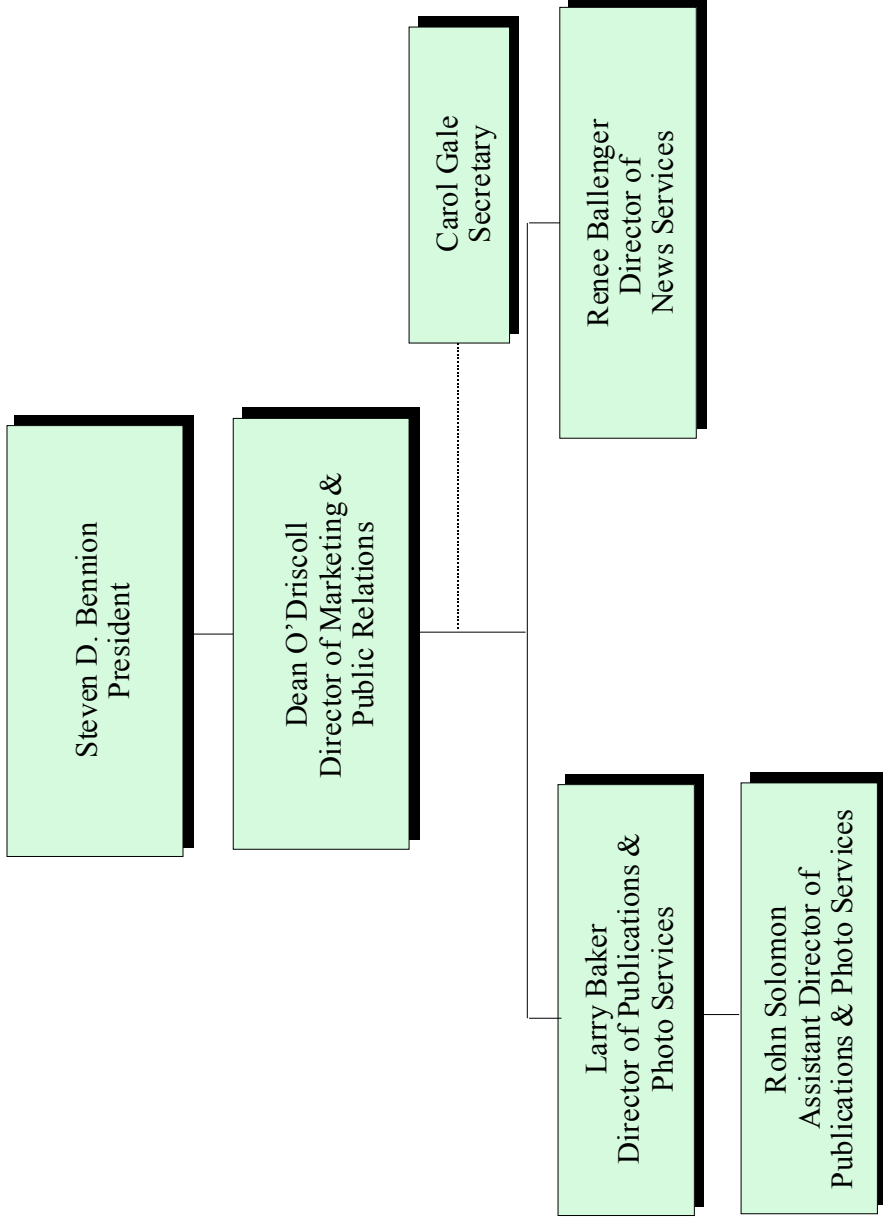

Southern Utah University

Administrative & Financial Services Organizational Chart

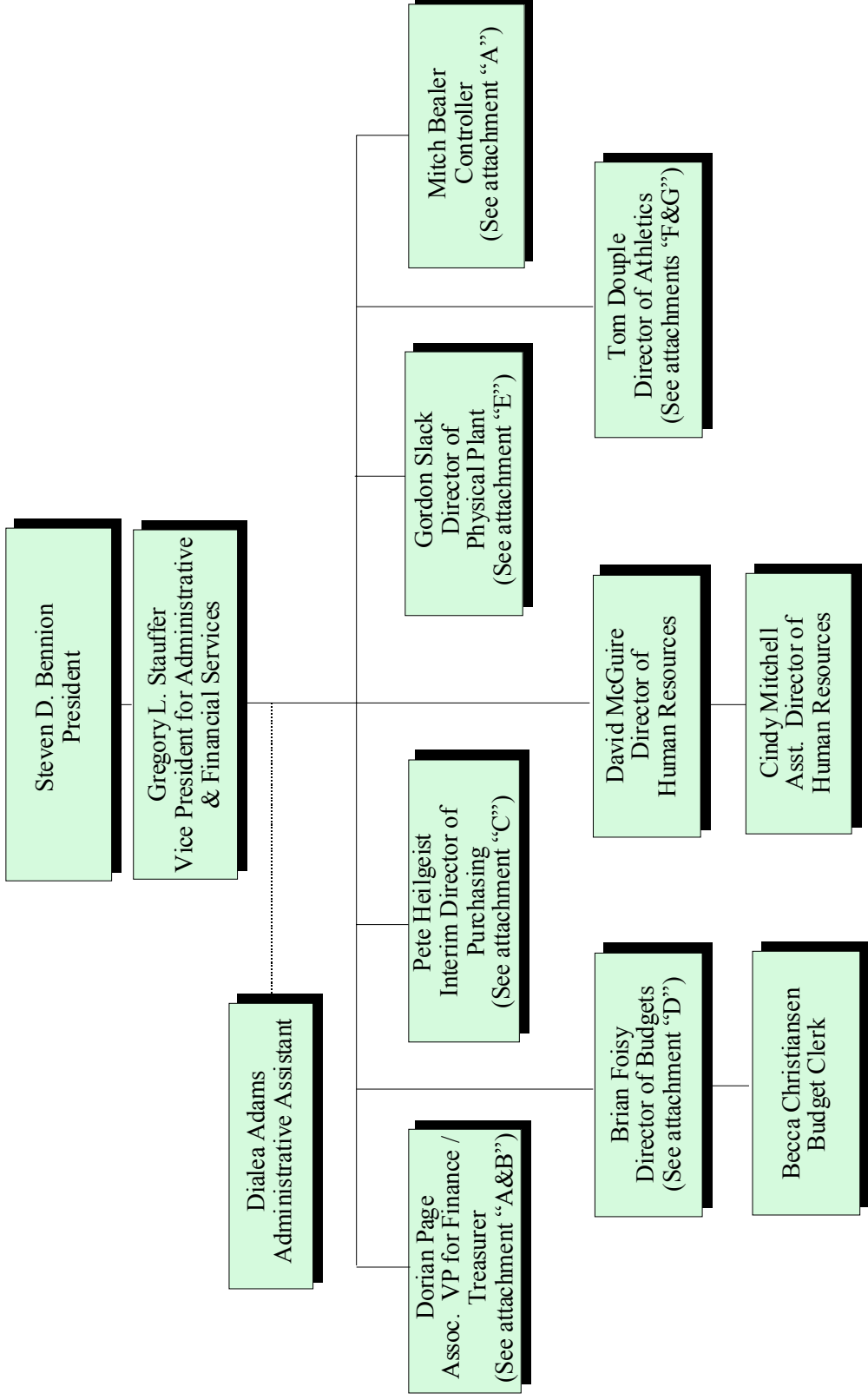

Southern Utah University

Administrative and Financial Services Organizational Chart

Attachment "A"

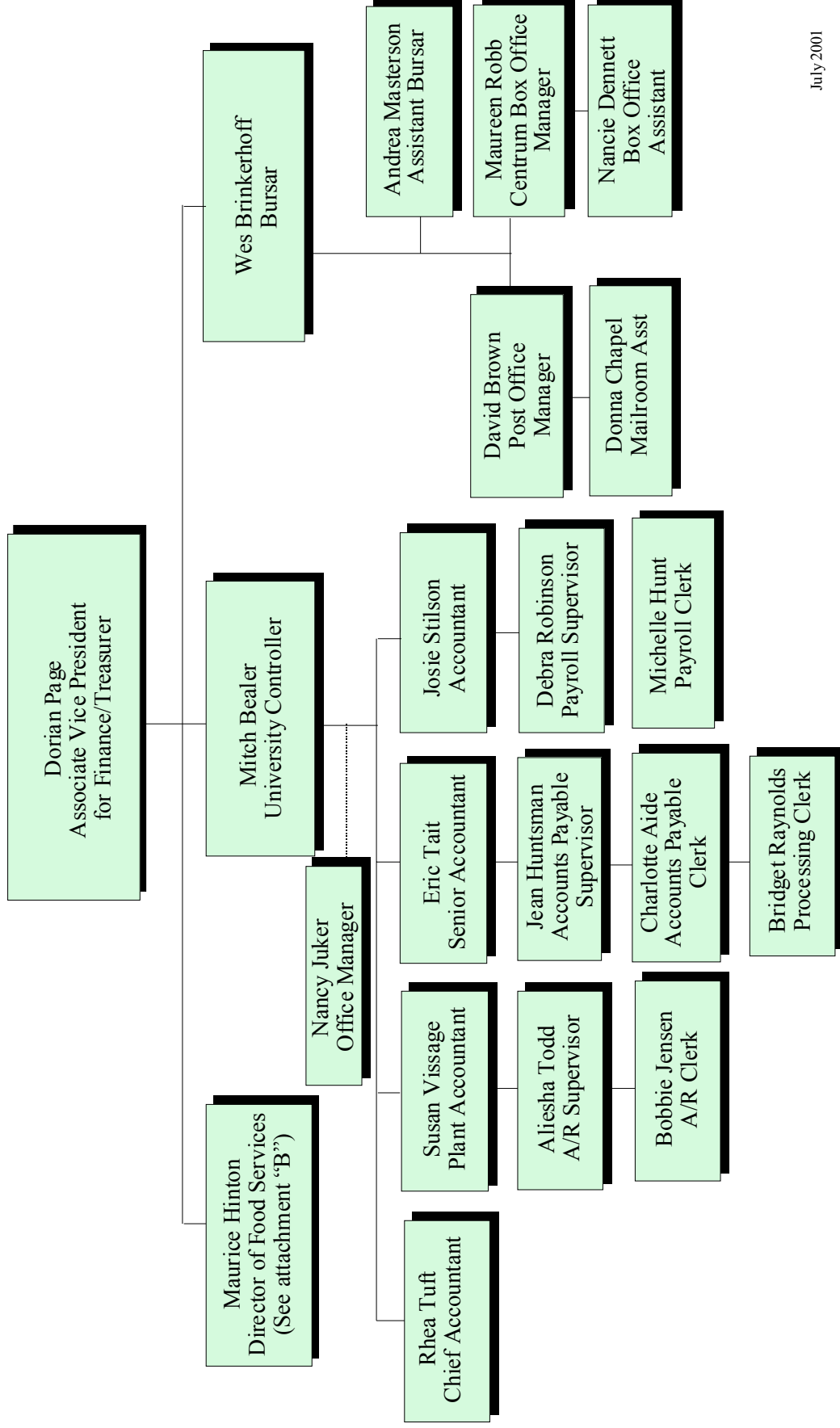

Southern Utah University

Administrative & Financial Services Organizational Chart

Attachment "B"

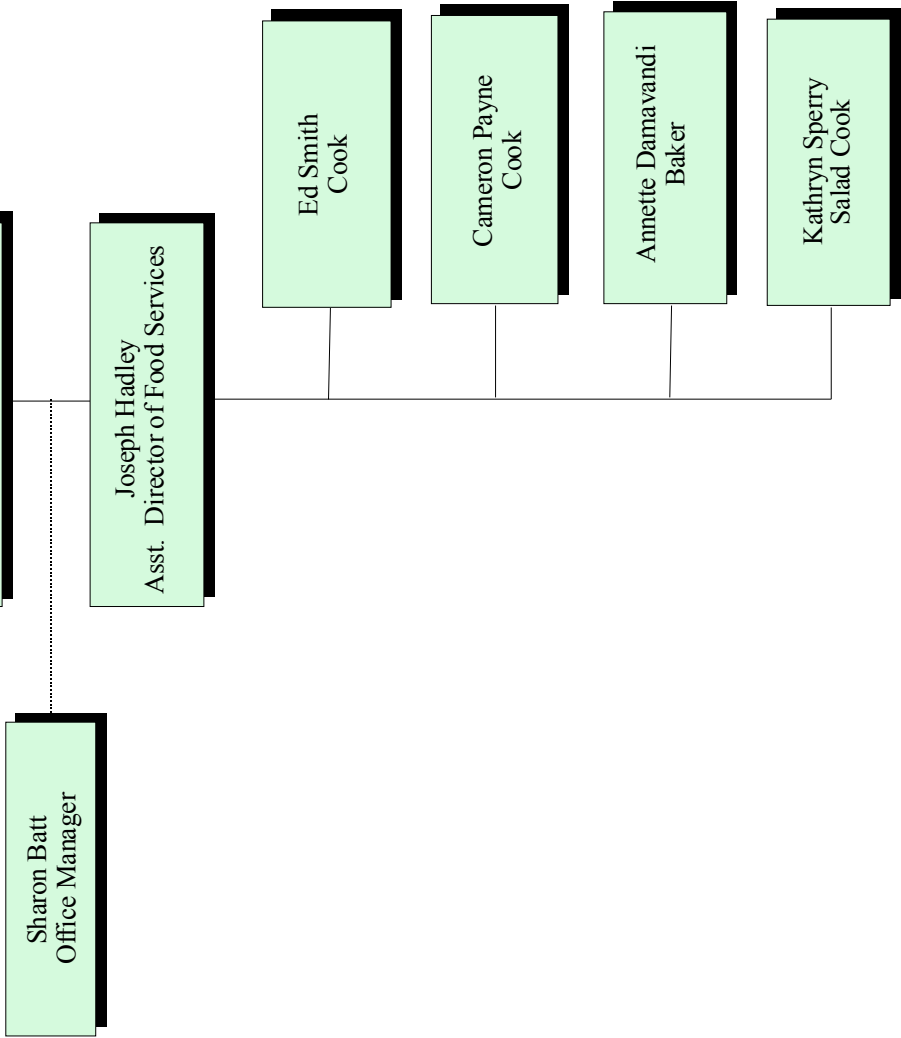

Southern Utah University

Administrative and Financial Services Organizational Chart

Attachment "C"

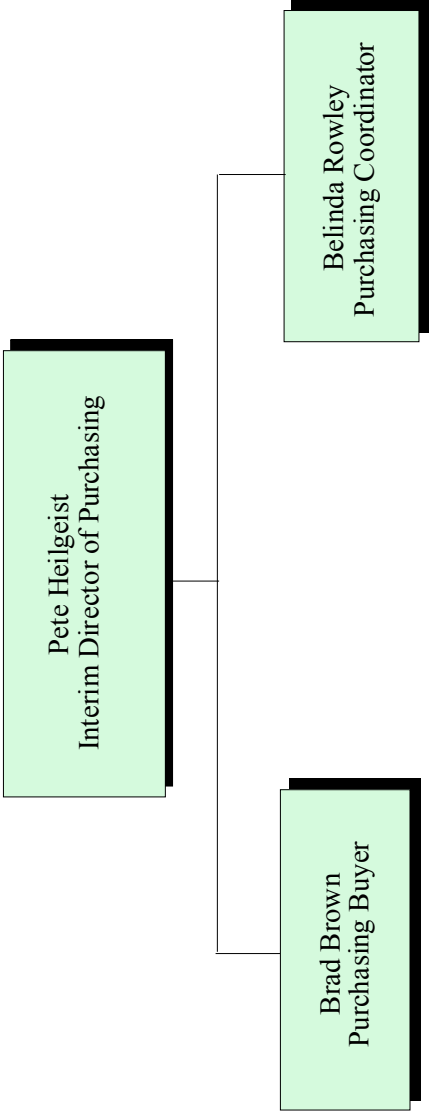

Southern Utah University

Administrative & Financial Services Organizational Chart Attachment "D"

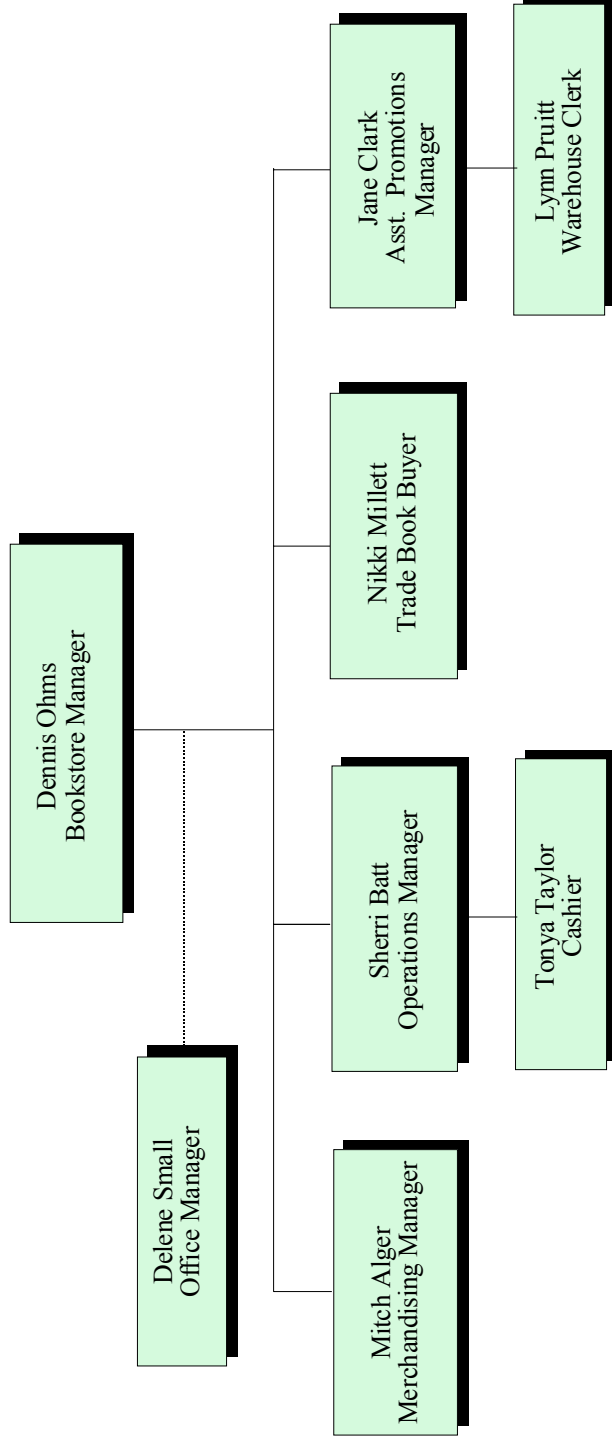

Southern Utah University

Administrative & Financial Services Organizational Chart

Attachment "E"

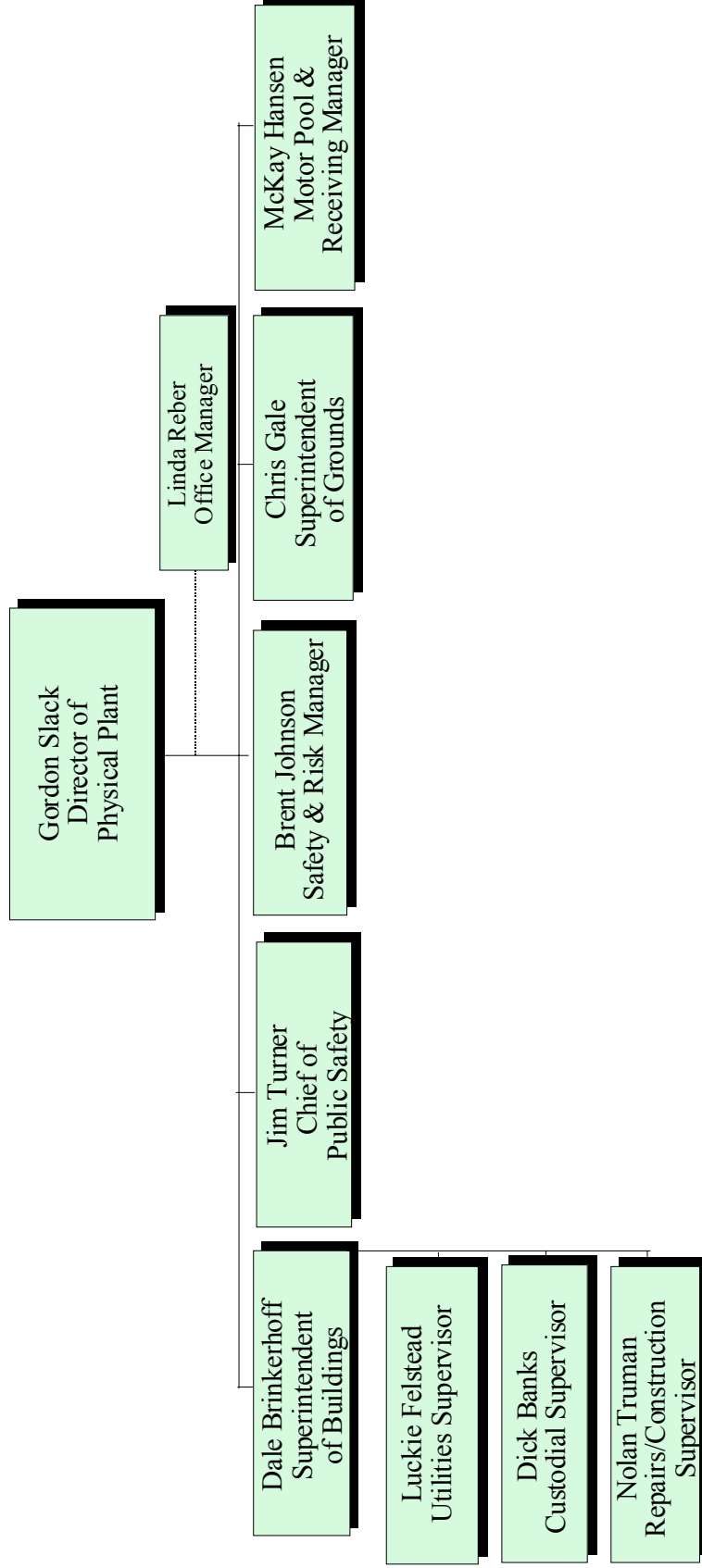

Southern Utah University

Administrative & Financial Services Organizational Chart

Attachment 'F'

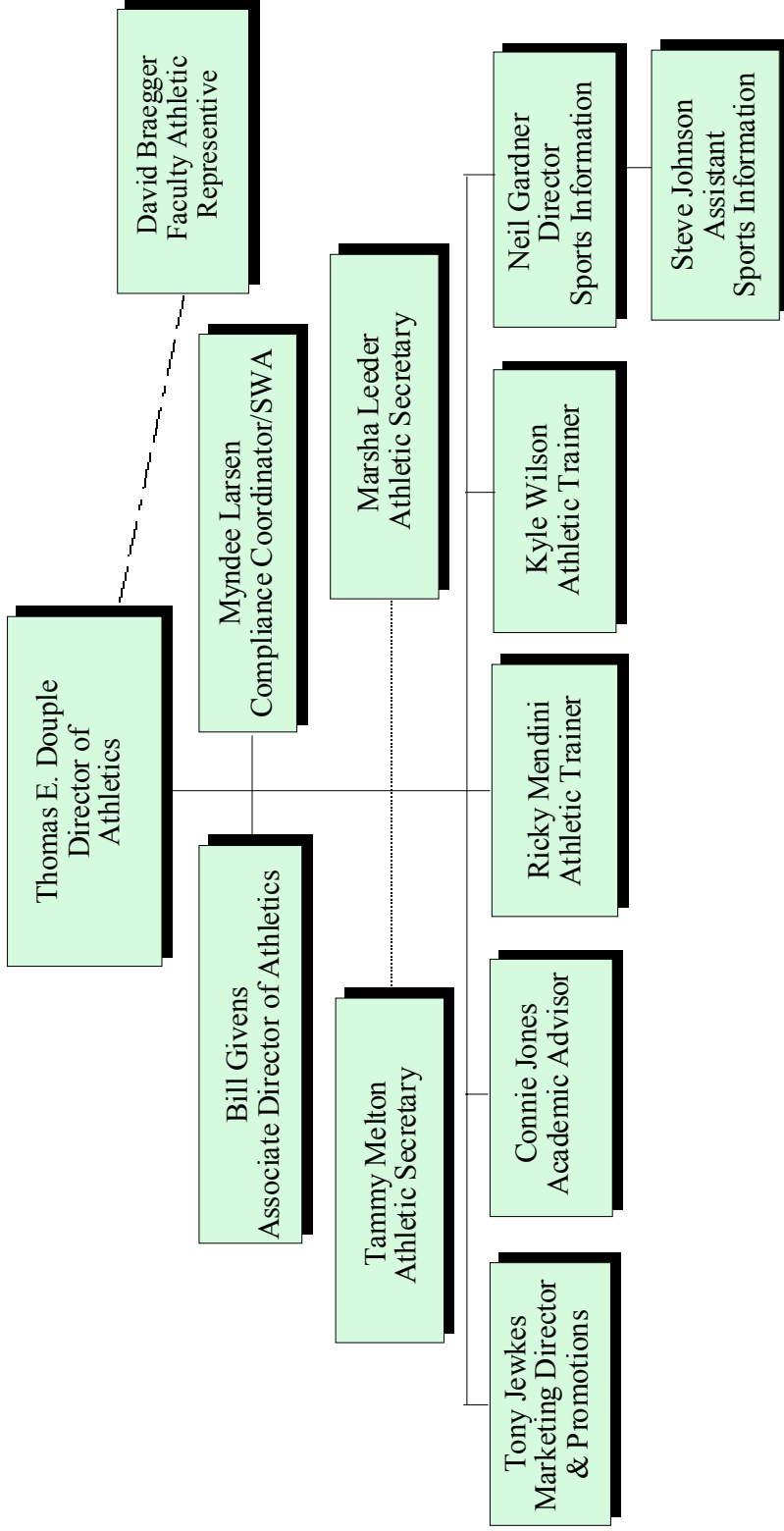

Southern Utah University

Administrative & Financial Services Organizational Chart

Attachment "G"

